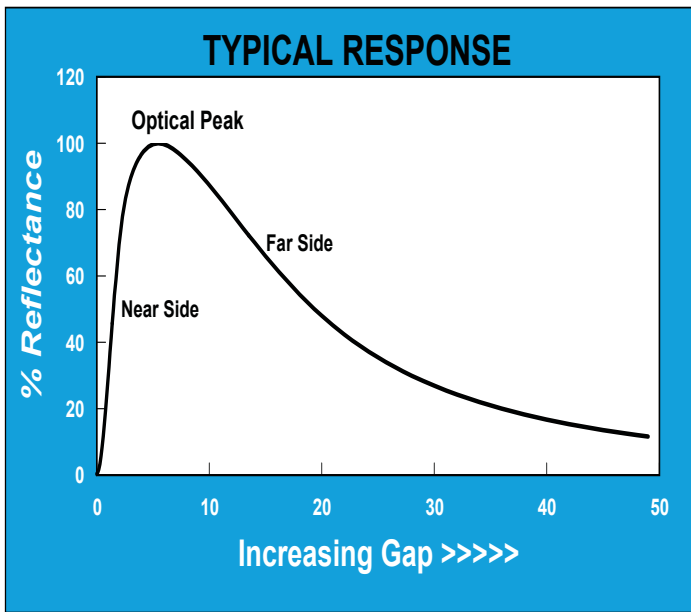
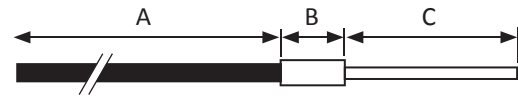

**Fiberoptic Sensor - Reflectance Dependent\*****Model D170**

Fiberoptic Cable &amp; Sensor Tip - Actual Size

**For The Measurement of Distance, Displacement and Vibration****Features**

- Reflectance Dependent Output with Dual Functions: Far Side/Near Side
- $\varnothing$  4.32 mm Target Spot Size (0.170 inch)
- 30 mm Total Operating Range (1.2 inch)
- 0.3 mv/ $\mu$ m Far Side Sensitivity (8 mv/mil)
- 25 mv/ $\mu$ m Near Side Sensitivity (600 mv/mil)

**Tip & Cable Dimensions**

FEATURE	mm	inch
Tip Outer Diameter, $\varnothing$ C	4.75	0.187
Fiberoptic Diameter	4.32	0.170
Tip Length, C	76.2	3
Collar Length, B	15.9	0.625
Collar Diameter, $\varnothing$ B	7.92	0.312
Cable Length, A	914	36
Cable Diameter, $\varnothing$ A	6.86	0.27
Cable Min. Bend Radius	25.4	1

\*These are reflective type transducers based upon detecting the intensity of reflected light. The output signal is proportional to:

- the gap distance from the sensor tip-to-target; and,
- the reflectivity of the target surface.

D models are commonly used in applications where the target reflectivity stays constant; i.e., the target has a reciprocating or vibratory motion parallel to the axis of the sensor.

**PHILTEC**

www.philtec.com

Precision Dynamic Measurements



## Two Instrument Outputs To Choose From

This sensor can be provided as an analog or as a digital instrument.

- Model D170 - analog output
- Model DMS-D170 ... standard DMS with RS232 output
- Model mDMS-D170 ... miniDMS with RS232 output
- Model muDMS-D170 ... miniDMS with USB output



**A**nalog sensors are fast responding units ideal for relative motion measurements in dynamic applications:

- DC-20 KHz is standard
- DC-200 KHz or higher is optional
- DC-100 Hz provides best resolution

Standard analog units include:

- Electronics with 0 to +5 VDC output
- 3 foot long fiberoptic cable

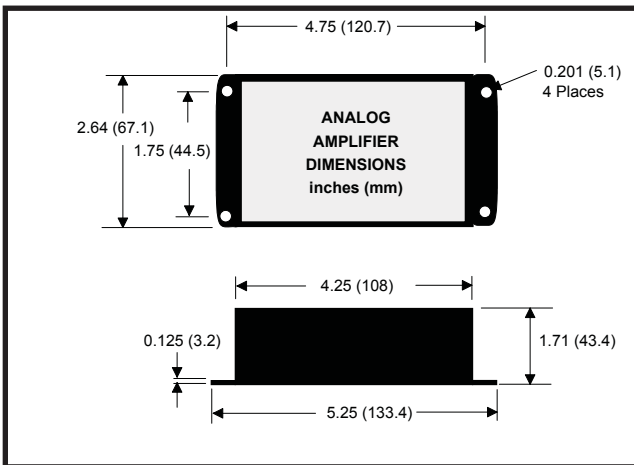

### ANALOG OUTPUT

Calibration charts are provided with each sensor tip giving the near and far side voltage output responses to distance. There are three ways to derive accurate distance measurements:

- within the bounds of the linear range, multiply sensitivity by the change in voltage output
- create a lookup table using the XY calibration data points
- use a polynomial curve fit to accurately map the sensor's output function

The effect of changing target reflectance is to shift the voltage output higher or lower. A gain control is provided for calibration of the sensor output to various target surfaces. In-situ calibration is performed simply, by adjusting the sensor's tip-to-target gap until the peak output is attained, and then by using the gain control to set the peak voltage reading to full scale. This allows the sensor to be used to perform precision linear motion measurements on most materials.

**D**isplacement Measurement Systems (DMS) are the best choice for absolute distance measurements, multiplexing and process control applications, with data rates up to 5,000 readings/second. They provide linearized distance output and on board calibration storage capacity for 25 calibrations. Three types are available, each equipped with temperature stabilized electronics:

1. **Standard DMS** units include:

- Electronics with RS-232 communication
- Keypad/LCD for local operation

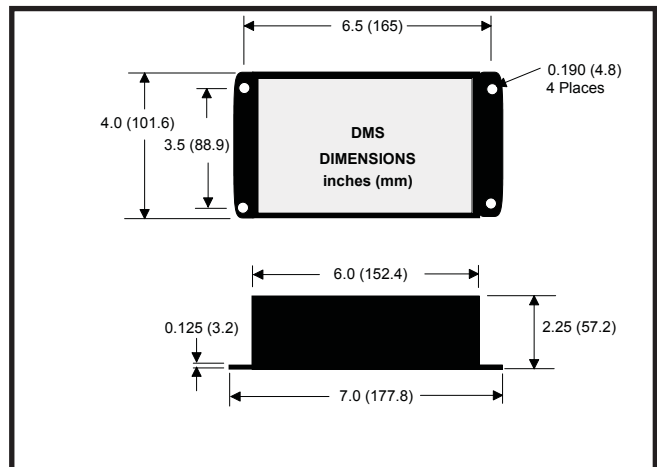

2. **Mini-DMS** units are full-featured for PC operation via RS232 communication, they are not equipped with keypad/display.

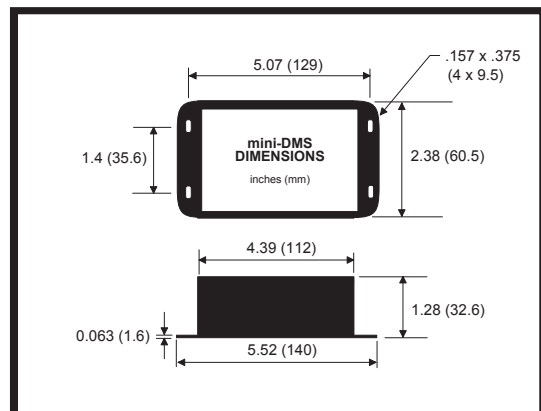

3. **muDMS** units are full-featured for PC operation via USB communication, they are not equipped with keypad/display. They are supplied in the RC analog sensor enclosure, 82 x 111 x 48 mm.

**PHILTEC Model D170**  
**Typical Response - Far Side**

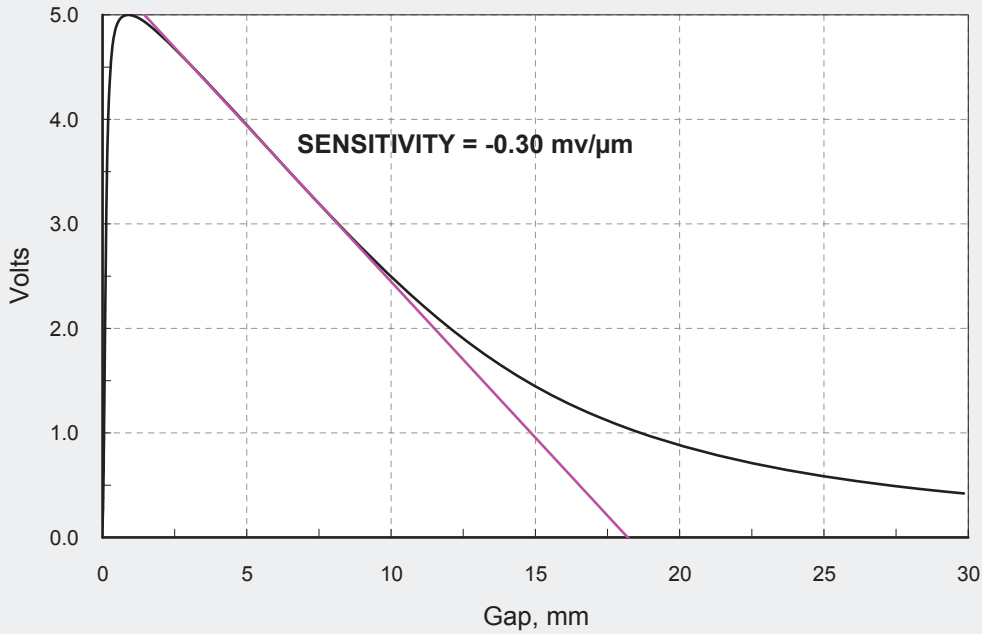

Linear Range, Far Side, ± 1% = 1.64 - 9.25 mm

Conversions

- 1 μm = 39.37 μinch
- 1 mm = 39.37 mils
- 1 mil = 0.001 inch
- 1 mil = 25.4 μm
- 1 mil = 0.0254 mm

**Standard Specifications - D170 Far Side**

Electronics			Fiberoptics		Outputs				
	Analog	DMS	Light Beam Spread	25°	Analog (0-5 Volts)			Digital (USB or RS232)	
Light Source	LED, 880 nm		Cable Sheathing	PVC over Steel Monocoil	Total Range	1.2 in.	30 mm	Total Range	30 mm
Input Voltage	+12 to +24 VDC	+12 VDC	Tip Material	300 Series SS	Linear Range*	0.260 in.	6.6 mm	Linear Range	30 mm
Input Current	125 ma max	500 ma max	Tip Epoxy Outgas	0.3% @ 200°C 2.4% @ 300°C	Nominal Standoff**	0.185 in.	4.7 mm	Reflectance Resolution	0.5%
Band-width	DC-20 KHz 3 db down	5 KHz max	Tip Operating Pressure	35 bar	Nominal Sensitivity*	7.8 mv/mil	0.3 mv/μm	Temperature Resolution	0.06°C
Iso-thermal Drift	0.5%	0.05%	Tip Operating Temperature	-55 to 175°C continuous; to 350°C intermittent 1-2 hours	Resolution**	DC - 200KHz 450 μin DC - 20 KHz 200 μin DC - 100 Hz 20 μin	11.5 μm 5 μm 0.5 μm	Resolution** Pk-Pk Units at Mid Range using 50% Signal Power	ADC AVG = 2    pk-pk = 2.5 μm ADC AVG = 16    pk-pk = 1.5 μm ADC AVG = 256    pk-pk = 0.5 μm ADC AVG = 4096    pk-pk = 0.1 μm

\*Standard Specifications provide nominal values only. Actual production values may vary by as much as ±15%.

\*\*These specifications represent best case performance where: the target is flat, smooth and highly reflective, the sensor is perpendicular to the target, the sensor is gapped to its range of highest sensitivity, fiberoptic cable lengths are standard and the cables are not connectorized.

NOTE: Nominal Standoff = the gap distance that places the sensor at the middle of the linear operating range.

**Custom Hardware To Customer Specifications**

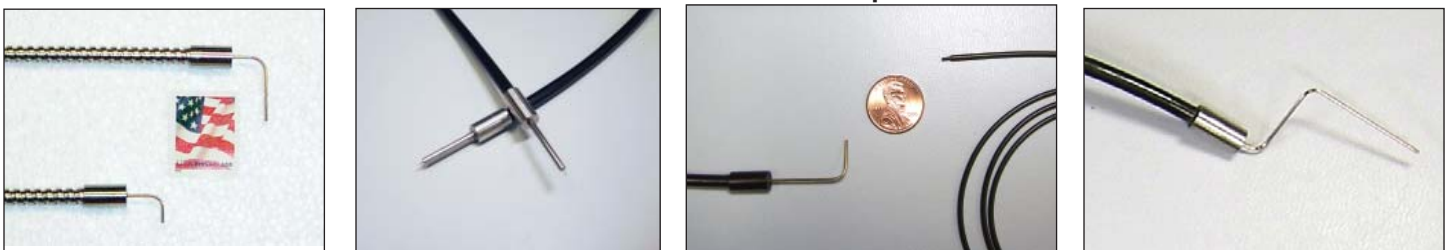

**PHILTEC, INC., ANNAPOLIS, MD USA 410-757-4404**  
**800-453-6242 e-mail sensors@philterec.com**

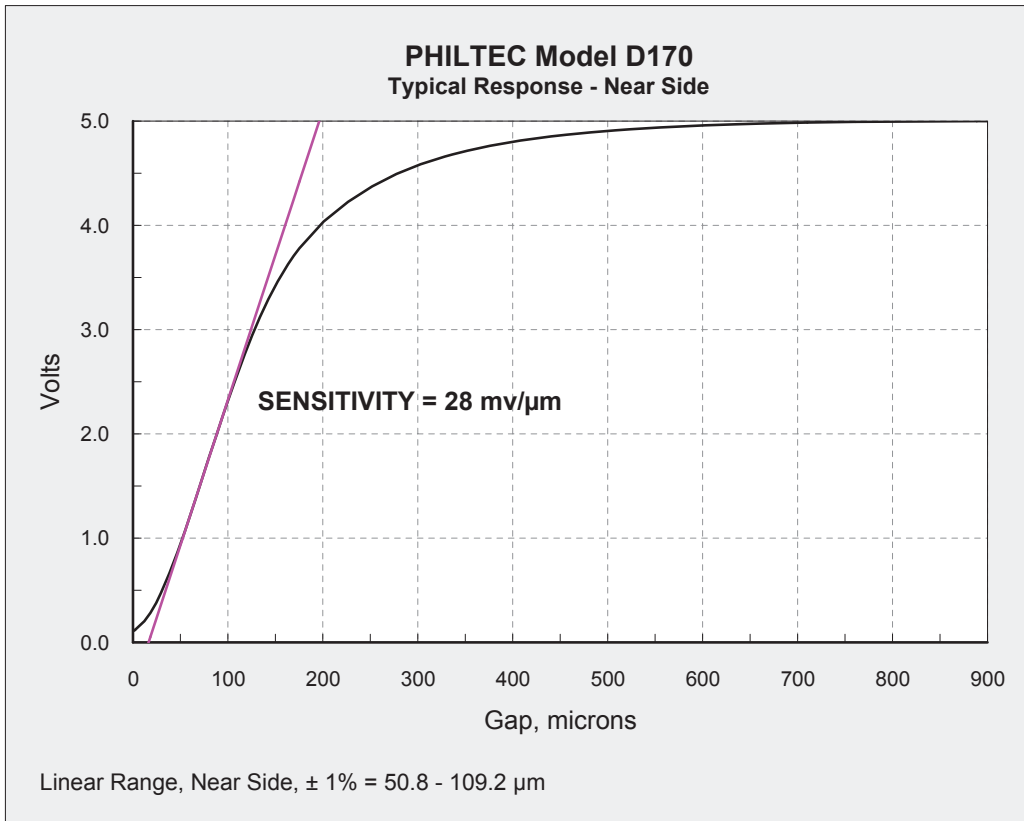

Conversions

- 1 μm = 39.37 μinch
- 1 mm = 39.37 mils
- 1 mil = 0.001 inch
- 1 mil = 25.4 μm
- 1 mil = 0.0254 mm

<b>Standard Specifications - D170 Near Side</b>										
<b>Electronics</b>			<b>Fiberoptics</b>		<b>Outputs</b>					
	<b>Analog</b>	<b>DMS</b>	Light Beam Spread	25°	<b>Analog (0-5 Volts)</b>			<b>Digital (USB or RS232)</b>		
<b>Light Source</b>	LED, 880 nm		Cable Sheathing	PVC over Steel Monocoil	<b>Total Range</b>	35 mils	900 μm	<b>Total Range</b>	<b>900 μm</b>	
<b>Input Voltage</b>	+12 to +24 VDC	+12 VDC	Tip Material	300 Series SS	<b>Linear Range*</b>	2.6 mils	66 μm	<b>Linear Range</b>	<b>900 μm</b>	
<b>Input Current</b>	125 ma max	500 ma max	Tip Epoxy Outgas	0.3% @ 200°C 2.4% @ 300°C	<b>Nominal Standoff*</b>	3.7 mils	94 μm	<b>Reflectance Resolution</b>	<b>0.5%</b>	
<b>Band-width</b>	DC-20 KHz 3 db down	5 KHz max	Tip Operating Pressure	35 bar	<b>Nominal Sensitivity*</b>	600 mv/mil	24 mv/μm	<b>Temperature Resolution</b>	<b>0.06°C</b>	
<b>Iso-thermal Drift</b>	0.5%	0.05%	Tip Operating Temperature	-55 to 175°C continuous; to 350°C intermittent 1-2 hours	<b>Resolution**</b>	DC - 200KHz DC - 20 KHz DC - 100 Hz	30 μin 15 μin 3 μin	760 nm 380 nm 75 nm	<b>Resolution**</b>	ADC AVG = 2    pk-pk = 100 nm ADC AVG = 16    pk-pk = 80 nm ADC AVG = 256    pk-pk = 20 nm ADC AVG = 4096    pk-pk = 10 nm

\*Standard Specifications provide nominal values only. Actual production values may vary by as much as ±15%.

\*\*These specifications represent best case performance where: the target is flat, smooth and highly reflective, the sensor is perpendicular to the target, the sensor is gapped to its range of highest sensitivity, fiberoptic cable lengths are standard and the cables are not connectorized.

NOTE: *Nominal Standoff = the gap distance that places the sensor at the middle of the linear operating range.*

**Many Options are Available Including Replaceable Tips, Vacuum Passthrus and Non-Metallic Tips**

